

**416 Push Side Top Jamb Drop Plate
Allows 120° Maximum Opening**

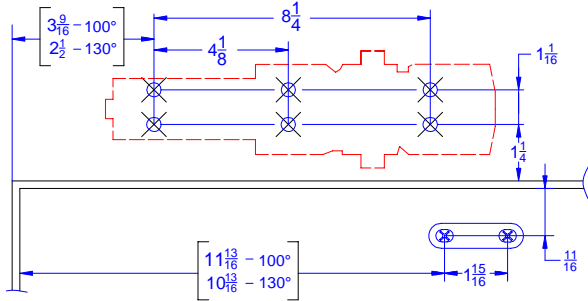

Left hand door shown, use opposite
for right hand door

**416 Push Side Mount :
416TJ-2 Drop Plate**

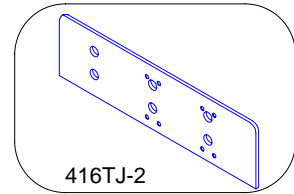

416TJ-2

Maximum Reveal : 2-9/16"

**416 Push Side Top Jamb Drop Plate
Allows 120° Maximum Opening**

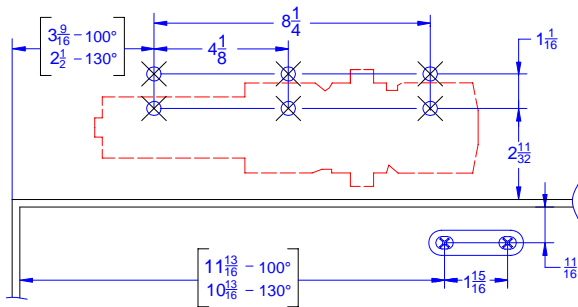

Left hand door shown, use opposite
for right hand door

**416 Push Side Mount :
416TJ-1 Drop Plate**

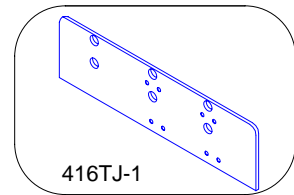

416TJ-1

Maximum Reveal : 2-9/16"

INCH	1 1/16	1 1/16	1 1/4	1 15/16	2 11/32	2 1/2
M.M.	17	27	32	49	60	64
INCH	3 9/16	4 1/8	8 1/4	10 13/16	11 13/16	
M.M.	91	105	210	275	300	

416 Pull Side Regular Drop Plate
Allows 120° Maximum Opening

416 Pull Side Mount :
416 Reg. Drop Plate

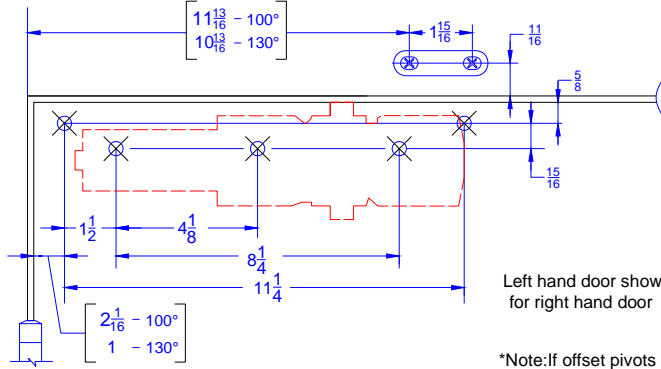

Left hand door shown, use opposite for right hand door

*Note: If offset pivots are used, increase these dimensions by 1/8".

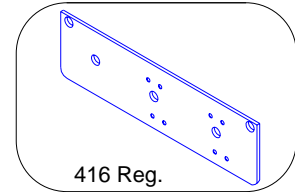

416 Reg.

416PA Push Side Drop Plate
Allows 180° Maximum Opening. Maximum hinge size 5" X 5"

416 Push Side Mount :
416PA Drop Plate

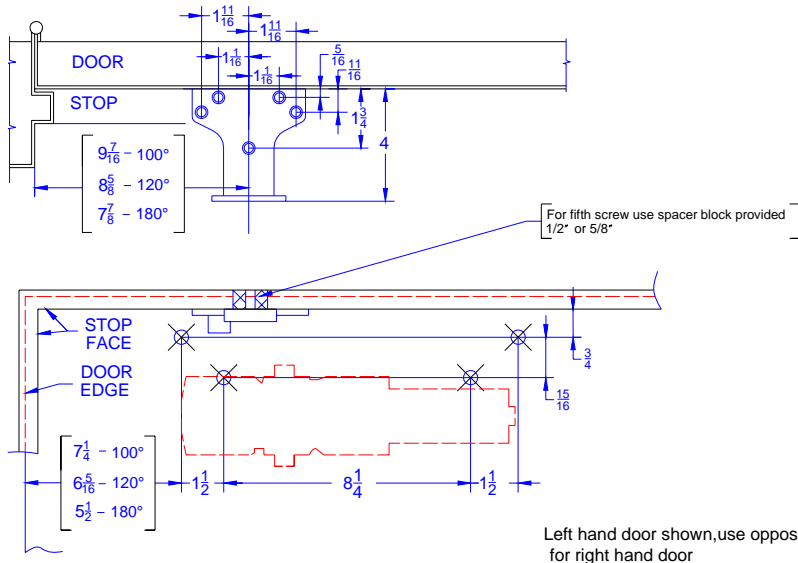

Left hand door shown, use opposite for right hand door

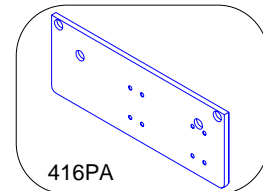

416PA

INCH	5/16	5/8	11/16	3/4	15/16	1	1 1/16	1 1/2	1 11/16	1 3/4
M.M.	8	16	17	19	24	26	27	38	43	44

INCH	2 1/16	4	5 1/2	6 5/16	7 1/4	7 7/8	8 5/8	9 7/16	11 1/4
M.M.	53	102	139	160	184	200	219	240	286