

HOW TO INSTALL THIS CYLINDRICAL LEVERSET

● Leverset is set for 1 3/4" thick door - Backset 2 3/4"

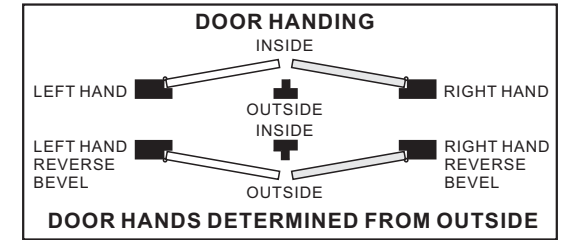
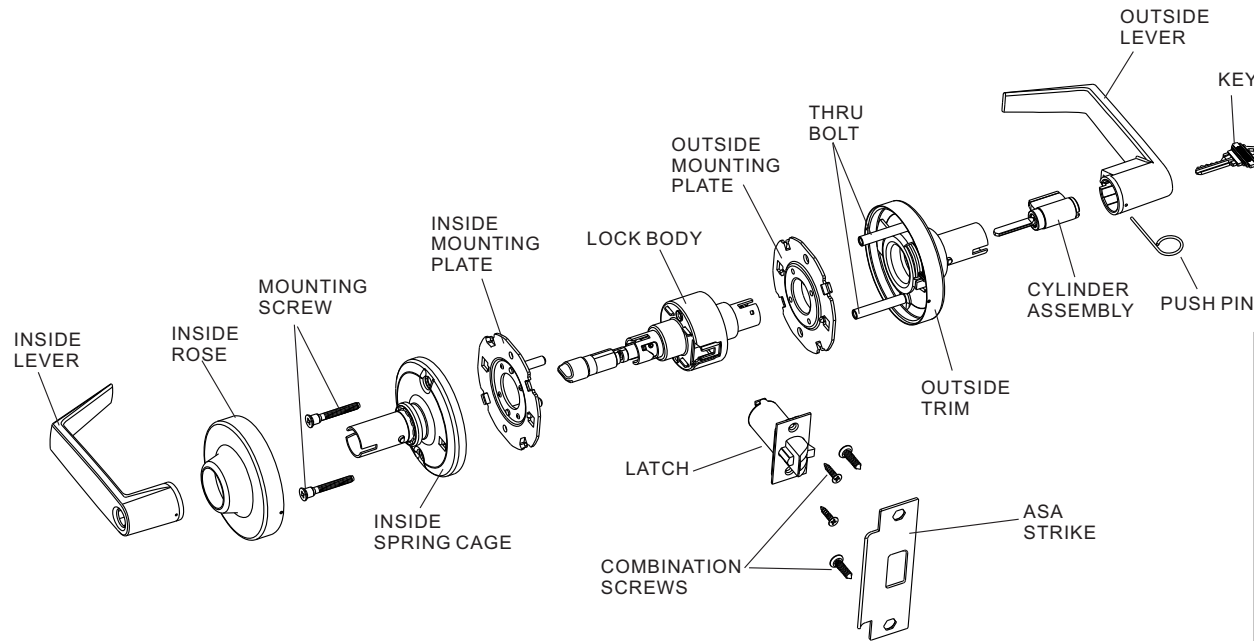

Install Latch

Prepare door per template.
Insert latch and secure
with combination screws.

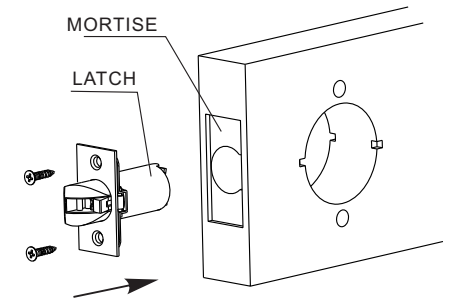

1 DISASSEMBLE INSIDE LEVER AND ROSE

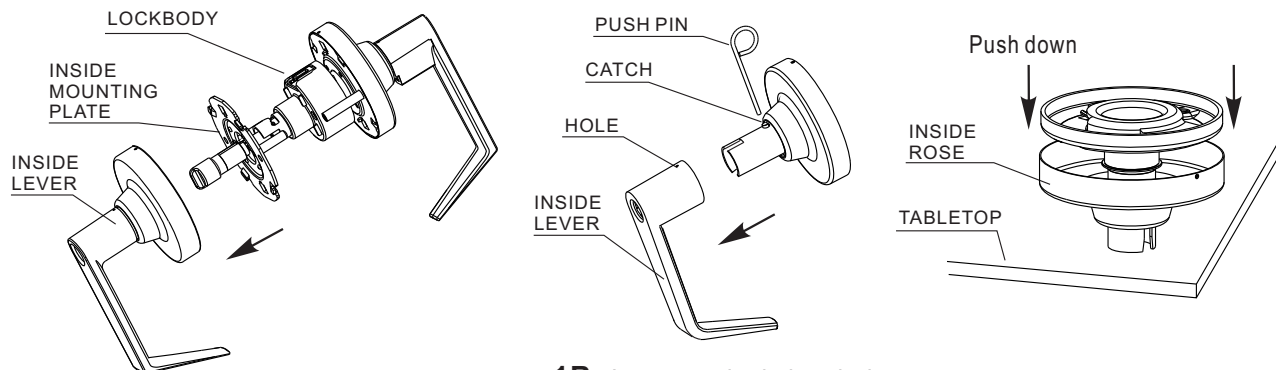

1A: Remove inside rose chassis and inside mounting plate from the lock body.

1B: Insert push pin into hole in inside lever to depress catch then remove inside lever.

1C: Remove the inside rose from inside rose chassis.

2 INSTALL LEVERSET ONTO DOOR

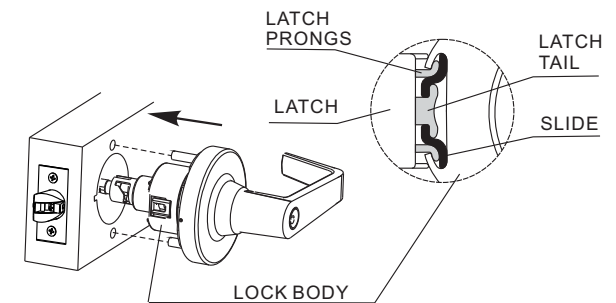

2A: Place lock body into position. Make sure that latch prongs engage chassis housing, and slide engages latch tail.

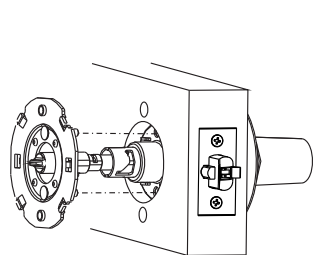

2B: Install inside mounting plate.

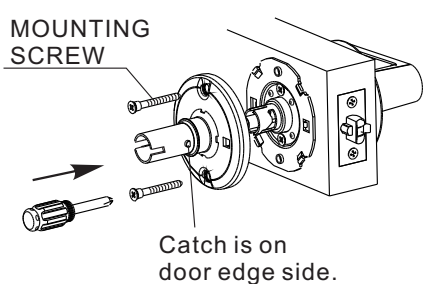

2C: Install inside spring cage and secure with two mounting screws.

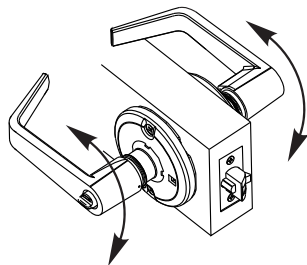

2D: Slide inside lever onto spindle but do not lock it into place and check to see if the rotation is smooth. Adjust mounting screw if necessary.

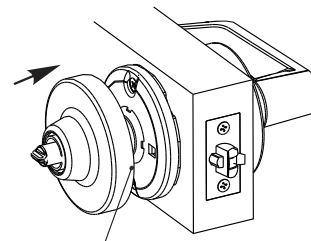

Align dimples on side.

2E: Remove inside lever and install inside rose, make sure inside rose is fully snapped in.

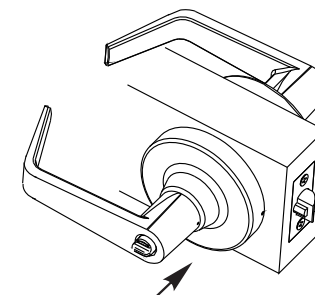

2F: Slide inside lever onto spindle. Push lever completely onto spindle until it locks into place. (Pull on lever to make sure that catch is fully engaged.)

3 INSTALL STRIKE

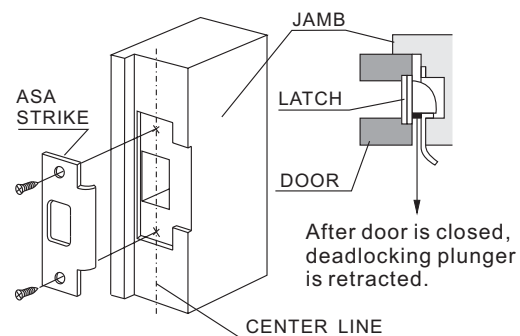

INSTRUCTIONS FOR ADJUSTING LOCK TO FIT DOOR THICKNESS OTHER THAN 1-3/4"

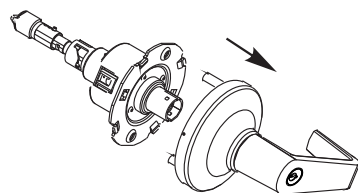

A: Pull off outside rose assembly.

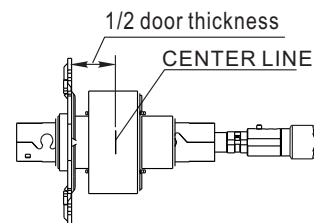

B: Turn outside mounting plate to adjust center line of lock body to match the centerline of the door.

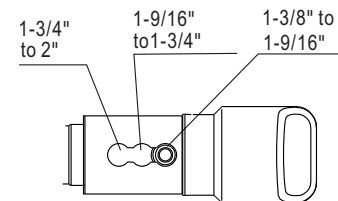

C: Adjust push button to the required position. The lock is factory preset for 1-3/4"

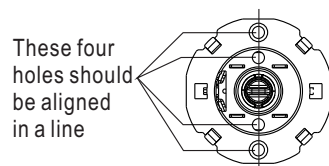

D: Align four holes in line when finish adjusting door thickness.

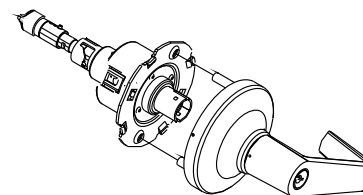

E: Reinstall outside trim onto lock body for next installing.

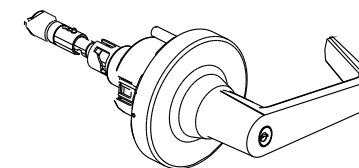

F: Insert key to check key function and make sure lock function is correct.

INSTRUCTIONS FOR CYLINDER REPLACEMENT

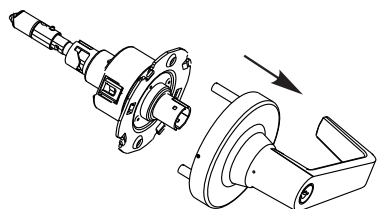

A: Pull off outside rose assembly.

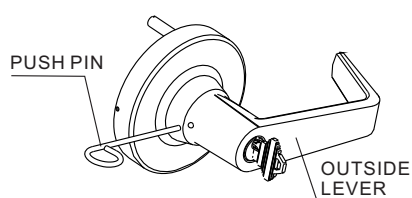

B: Turn key 90 degrees, Insert push pin into hole in outside lever to depress catch.

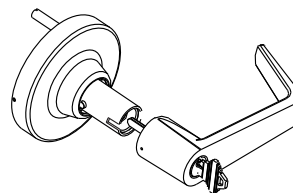

C: Remove old cylinder. Install a new cylinder, turn key 90 degrees, then put in outside lever onto spindle.

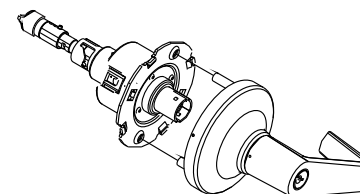

D: Pull out key, then install outside trim onto lock body for next installing.

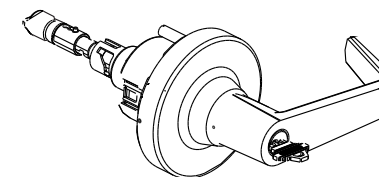

E: Insert key to check key function and make sure lock function is correct.